

M7

The figure of Eight.

By Leonard Van Zanten.

Email - vanzantenleonard@outlook.com

ABSTRACT

What is in an eight but that it is twice four, yet it is the most dominant rule in the entire universe. The figure eight of movement that empowers, and construct all things, a most marvelous innovation by the hand of God. But to know how this is so requires a mind of wisdom and insight into the works of the Almighty Creator.

KEY WORDS

Movement, Magnetic, Electric.

ESSAY

Who now is able to speak of the eight of force other than those whose instructions are of the Almighty Creator by whose hand the whole of the universe came into existence? **Every star, and every planet is empowered by eight; even as every single atom has it's being by the eight of force,** or of movement as it may also be said.

How is a magnet constructed to have its power in movement? It is a mere block of metal yet it attracts and repels to other metals, it must therefore inhibit some sort of movement by which the attraction and repulsion come about. And yes it is movement, but not the kind we normally associate with movement, or displacement.

Should it not be curious for a piece of material to exhibit movement? And how will one interpret that? We call it magnetism, but what might that be to display movement? Shall it be by some single sided coins to buzz around; as if either magnetic or electric can be found single sided? Does not everything in nature make hogwash out of these theories?

Employing simple logic, if a rotating movement passes through or inhibits a metal like electricity the metal cannot retain it, because it is in the figure eight of movement that it may and or is able to lock itself in place. (This word is for the discerning) In the way of movement now there but two distinctions, it is either **linear or angular**, no third distinction exists, **and by these two all things have their form as well as being.** A bold statement perhaps.

How thus did either of these come to be, movement to movement that is? First and foremost movement as such has to be created, it has to come into existence, be it unique

in itself, as the fundamental movement is, or that secondary movement as upon collateral objects. And yes that fundamental movement was **created by the Almighty One who called it forth to exist, and by which He formed all that is visible from the invisible,** His entire tent to dwell in that we call the universe.

And how unique indeed, when we look at Figure 1, here we see two circles by which that certain movement proceeds within and upon that block of metal. But sight deception being prevalent among man has him in a bind, since these are but a single circle tracing their direction of movement by what we call **a figure of eight.**

A circular movement now is called angular, and how then do we come to a movement in the linear? It my dear reader is by the design of our Almighty Creator a product of the angular as it proceeds by the pattern of an eight. At what we call the North the movement of that eight is out-ward's and coming around to the South going inward. Here we have the birth and construction of linear movement proceeding from South to North.

As then that particular movement best known as **Fundamental Movement** is conductive as well as **directionally conductive**, when the directions are alike one another these join, with un-likes to repel from one another. This is indeed so all because that movement **unlike any and all other movement is conductive.** The direction in the wind may appear as if it is conductive because all atoms move in the same direction. But here it is pressure; as in higher-pressure verses lower pressure, just as an airplane stays aloft by the same principle.

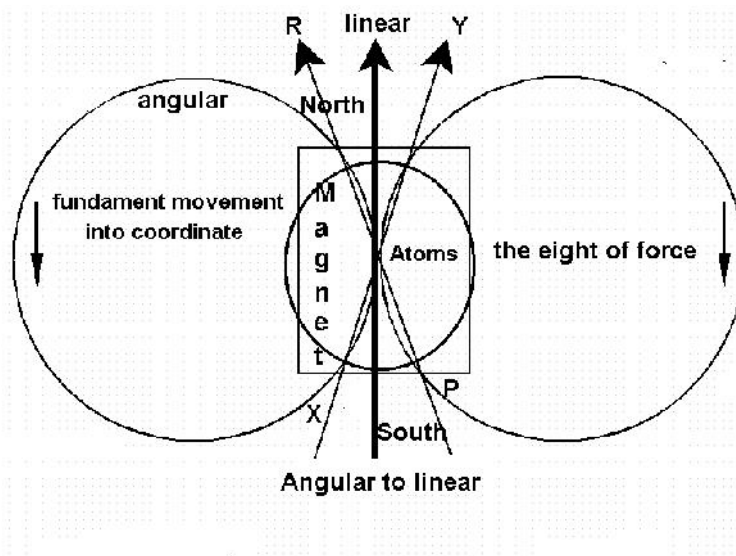

Figure 1

Now we will come to ask how that first and foremost angular movement came to be, and/or how did, or does it come to proceed by an eight? Here however I must come to curtail some of my speech. Its existence is by the hand of God, and God only knows how that is, something not suited for the residents of this world. But that it comes to an eight

can be understood when one is granted insight, by which in elementary terms all atoms came to exist, something still held in secret.

Or how does one suppose light and radio waves go from one place to another, and that at a fixed velocity? **What is the driving agent of these waves?** Magnetic and electric - so the blind acclaim when they have no clue as to the nature of either magnetic or electric, poor souls. No one atom could or would possibly connect, or adhere, or repel from any other atom if it did not inhibit that fundamental movement of eight, as any and all other magnets possess. No fundamental linear movement whereby any two atoms cling to one another can exist unless its movement proceeds as illustrated by Figure 1.

And I should repeat this, how no linear movement could or would exist if it were not for the eight of force or movement. These wave-like coordinates now are driven forth through the air and space by God's fundamental power of movement **riding dependent upon the media in space as well as anywhere.** Full size magnetic entities are found at and by any star and planet, not buzzing around in the open just to serve the blind.

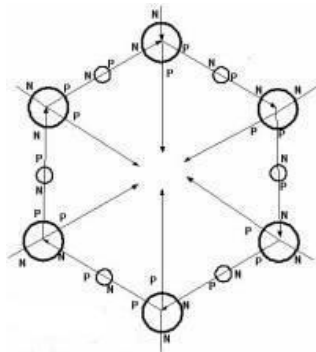

Figure 2. (Ice)

Illustration Figure 2, shows the particular coordinate of water into ice. Each of those 6 Oxygen atoms directs either their South, or their North polarity to a single center. That is how the open space is formed surrounded by a dozen atoms holding to one another in that circular fashion by what is called their magnetic coordinates. The reason for the Hydrogen atoms in between the ones of Oxygen is because the true north and South the Oxygen atoms are offset wherefore it requires another atom in between any two of the Oxygen atoms to properly bind together. Elementary said yes, but true.

If anyone believes upon man's theories the atom to consist of positive and negative parts whereby these are held together, **he is totally blind and ignorant of the daily facts around him, how positive to negative never at all attract nor repel, but rather in contact with one another destroy each other.** Short circuits are a clear demonstration of what I just said. How therefore man is blind in the fundamentals of the sciences. And yet they wish to teach me, as if the All Time Teacher who constructed the entire universe should not know His own work. These of course consider themselves wiser than the Almighty One who was my only teacher, for all the days that I have had my exile on this planet.

"I now - so said the Lord, "will make fools of all of them that are wise in the earth." And indeed they will all be put to shame, and come to some horrible regret for the words of their lips. If there is any kind of knowledge and common sense within anyone he or she ought to realize how truly ignorant man's scientists are. And at the same time **realize how knowledge and truth are of God alone**, and found upon the lips of those that are called His sons, whom are taught of Him, in His Spirit.

Does anyone have even an inkling of what electricity, and/or magnetism is? None of man's scientist do, yet I know them perfectly but only because I was taught from above, from the very Creator of them. Nor was it these alone that He taught me, but insight into most all of the fundamentals of His creation. Am I now commending myself? No not me, but Him who taught me. If I were to make a boast it will be that I know Him, the Creator of us, and understand Him, that alone is my boast.

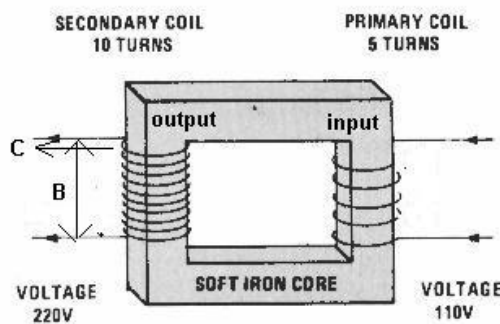

Figure 3.

Here by Figure 3 it is evident that electricity for its voltage; (that in factual terms comes down to "speed of rotation,") is by turns, by turns of movement. Once electricity is obtained it has a certain speed of rotation by the number of turns in the armature and speed of its generator. From here on that speed of rotation can be altered simply by adding turns, **be they physical turns, or none physical**. In the illustration Figure 3, the metal core acts as a pump or a flywheel for the alternating direction of movement placed at the input.

With equal number of turns at the output and input, the speed of rotation would not change, since that core as a flywheel is driven at the rate of 110 rotations per second. And yet at the output that speed of rotation has risen to 220 turns per second, all because we added additional wire turns, **physical turns that is**, by witch the flow of current is to pass.

The core as the flywheel produces only 110 turns per second, no matter how high the output may come to. The net output therefore may be 110 plus however many additional turns are laid around that core for the electricity to pass. **So you see how electricity is turns of movement, and that of magnetic.** And why do I call it magnetic? Because that is our commonly accepted term for that phenomena, or else I might have given it a different name. Although I did give it a designation.

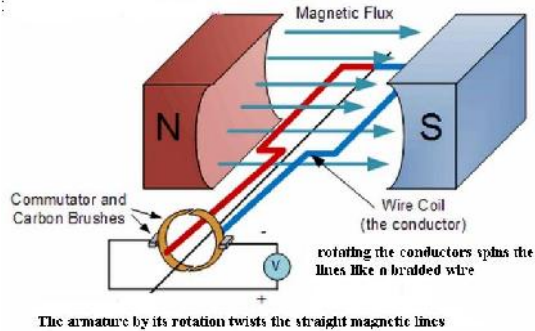

Figure 4.

And why should it not be so, since in producing that rotating field of magnetic, we in all essence, (illustrated by Figure 4,) are twisting those stationary linear lines of magnetic into a frenzy of turns by the armature placed and rotated within that magnetic field. No wonder therefore that around any conductor of electricity there appears to be a magnetic flow turning in the same direction by which the current turns. That magnetic flow then is none other than the exterior of any magnetic field, just the same as it is with any magnet, and every atom. Reference to Figure 5.

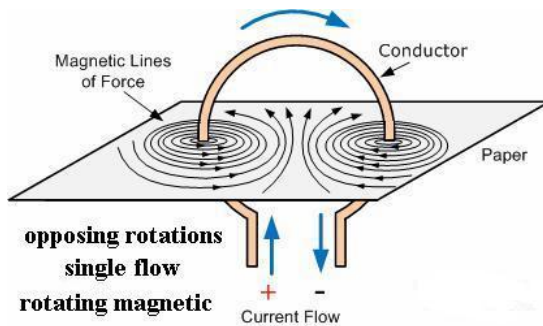

Figure 5.

Here by Figure 5, as the direction of rotation at the plus end passes unchanged through the entire loop ending at what is noted as the minus, **how do you see the direction of movement at these two ends, the plus versus the minus?** Obviously they are in opposite direction of one another, one clockwise, with the other counter clockwise/ And what happens when we touch two grinding wheels in opposite direction of rotation from one another to each other? Short circuits yes, the two tearing each other to pieces because each attempts to bring the other to its mode of travel. **Positive to Negative therefore never at all attract, nor repel from one another.**

And since that evidence is so clearly displayed in all that we have and do, how can anyone be so blind to suggest that these so called positive and negative parts within an atom join to each other? It is **indeed ludicrous**, completely contrary to all evidence and common sense. No such parts as electrons or protons exist **anywhere these are no more than the imagination of the blind**, of men without eyesight, or insight. The only way any atom can possible connect to, adhere, or distance themselves from one another, is by what we understand as magnetic, **for in magnetic alone is the linear flow of movement**

produced by which any one part has the means to lock onto any other of the kind. There is no other way, nor is there any man to disprove me however much they would like to.

Am I not making perfect sense? Did not the Almighty One grant me a good understanding and insight into fundamentals? All the evidence in the world and universe supports me, how then can we go wrong? The future generations will not accept any of man's theories; they will all be trashed for the truth at hand. Whoever is honored for any of these theories will come to dishonor. Your Einstein is one of them, who never in his life got anything correct, not a solitary thing. And yet you glorify that gross ignorance? Shame on you! Yes shame on you!

Shall I speak a few words on gravity, how that comes about? Let us be careful now for the Almighty One by His prophet Jeremiah proclaimed that if any man can discover these foundations, He will not save any man, but cast the whole human race down for their sins against Him. Since then I know these foundations quite well upon which the earth rests, I better not know it of my own cunning, or I will be the death of everyone.

Thank God however I never did discover these foundations, they were taught unto me, by none other than the Creator Himself in His Holy Spirit. Like as He enlarged king Solomon's mind with wisdom and insight, so He did unto me, in a measure less than that of Solomon. Since thus it was God Himself who revealed these foundations upon which the earth rests, we will not be cast off, and Christ Jesus did not offer Himself in vain for us.

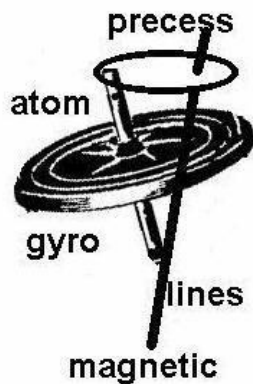

Figure 6.

Have we ever heard of intertwining, when something wraps itself around a needle or a stick? It is in that principle of movement that all things are held to the earth. First and foremost the earth as a magnet extends its magnetic lines of movement everywhere, depicted by the line in Figure 6. The atoms on the other hand whether they spin or not always have that angular movement within and upon them, wherefore as such they may be seen or likened to spinning tops.

A spinning top now will keep itself upright or in place simply by its own angular movement, and it will not budge from it unless acted upon to the contrary. (Our famous

law) And so what happens when a spinning top is nudged sideways at its axis of rotation? It, as we know, begins to precess, illustrated by Figure 6. That precession then is like wrapping a string around a needle. As then the magnetic movement of the atom is directionally conductive even as earth's magnetic movement is directionally conductive, the atoms become bound to earth's magnetic field that draws everything to its center of force.

I then likened the downward movement of all atoms unto a nut turning on a long bolt. If the g/force were 32 it will accelerate at that rate of rotation. Higher up where the g/force may only be 28 it will accelerate at that lower rate and increasing as it nears sea level. (Our famous ft/second/second) No weight of any kind will fall faster or slower than what rate of g/force it is bound to. This is so since **no object ever falls, it is driven, it is coerced.**

But how are these atoms on mother earth nudged into the linear whereby their precession may come about? Quite simple, the earth not only turns around its axis, but also moves in orbit around the sun. These movements alone are sufficient to bring every single atom to its off balance whereby it becomes intertwined with the earth's magnetic field. **The power of gravity therefore is magnetic.** And we are drawn to the earth by magnetic power. Nor are we drawn to the surface of the earth, **but rather to the center of center of the earth.**

There are however some variations in that the earth rotates, which means that at every point on the earth we are also drawn to the axis of the earth, an axis that is 8000 miles long. Since however the bulk of the g/force upon us is by the whole of the earth, the incline to the axis at some midway point between a pole and the equator is minor.

In addition to these there is the moon elongating the magnetic lines directly between it and the earth, by which the tides come about, and even us, to tilt our alignment to earth's center by a minor degree. This is easily proven with a sensitive instrument, one way to prove me wrong, only it will prove me right. If not so, I would not have said so, **Since then all magnetic is by the pattern of an eight, there must always be two equal tides on opposite sides of the earth.** Closing the handles of a pair of scissor also closes the cutting edges.

This is but an elementary lesson in gravity. And Sir Isaac Newton was quite correct in his law of motion as well as his law by which to calculate the factor of gravity. If thus we place ourselves behind a calculator, we are bound to discover that earth's gravity extends only a little more than 3000 miles out from its center. That alone is conclusive evidence that none of the stars or planets are held gravitational, but rather magnetically.

And so how in more than 3 centuries do I have to be the first and perhaps only one to factually utilize that law? Is not mathematics the same for everyone? **With all the advances in the sciences and we have yet to cope with mathematics?** Even man's astronomers have no clue how to apply mathematics in determining the velocity of any object in the universe for its radial velocity. At these things they are less than babes. It's a shame yes, but nonetheless a proven fact.

Light for its nature of being and its mode of travel is most fascinating, the very fact that the world becomes us by no more than minute variations of movement. When a line of so-called movement strikes our eyes with no variation, it is darkness to us. But when there are angular movements striking our eyes, it becomes us as illumination, like as in to see, to behold. Then as these rotating angular components, (as nothing more than coordinates of movement) vary in length, also meaning in angular deviation, they become us for what is known as color. In other words **vision as well as color is a faculty of our spirit, that we interpret from mere variations of movement channeled to the brain.** Sound is likewise a faculty of our spirit, to apprehend words from nothing more than minute vibrations, minute movements.

And so what is light? The angular movements that strike our eyes **are not light, but simply a mechanical innovation by which light becomes us.** Waves as they are erroneously called, seeing **they are not at all waves,** but angular moments driven by the fixed velocity of God's fundamental movement that He spread forth throughout His entire universe. It will do us well to learn how that mechanical innovation operates and proceeds for its velocity that appears to vary according to what we call lengths that in turn comes to color. The particular velocities that we obtain are not the real velocity, but rather a "**relative velocity**" one for distance in time. The real velocity is the fixed speed at which the fundamental movement moves that by us is called, "the Constant." and rated at 300.000 km/sec.

To utilize an illustration Figure 7, here - from mans measurements - I mathematically obtained the diameter by which that so-called light travels, as in- "**being driven forth.**" It being 1.5414-Angstroms, just sufficient to pass the lighter elements, wherefore these are never seen. Glass and air for example being transparent, but for the larger atoms not being able to pass around them these so-called angular moments of light enter in by them, that in turn remits the particular coordinate of that atomic structure and is seen by us for illumination as well as color.

Here by Figure 7, the "**angular moment,**" as I call them, is illustrated by one full turn from A over C to B, as it is driven forth around the atoms small enough to pass, making contact upon each and every atom in its path. (Obvious from the haze upon a warm roadbed) As thus A/C is the nominal length, the factual length is A/B/C, somewhat longer than the A/C length.

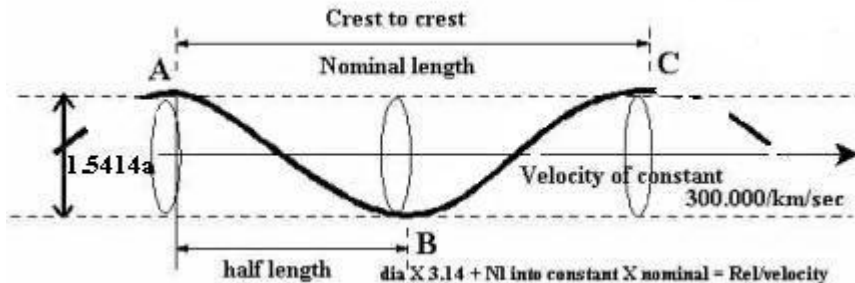

Figure 7.

When therefore that angular moment is driven forth by a fixed velocity of 300.000 km/sec, its velocity for distance in time from A to C is somewhat curtailed. When by example we take the red at 7000a, meaning A/C is 7000a, the nominal length. The real length will have to incorporate the circumference by which it proceeds, and that being 4.84a. When thus we divide the real length into the constant, and that multiplied by the nominal length we will know exactly at what speed that red so-called wave travels for distance in time.

Example; $300.000 : 7004.84 = 42.82$ -etc, and that times 7000 = 299,792 km/sec. That is 208 km/sec less than the constant all because it was driven forth in a circular fashion around the atoms in its path. Here if the nominal length is less than 7000, then the angle of that angular moment also changes, and it is by these angles that we interpret color. Observe closely now how it is not length that changes the angle, but **rather the angular path of that moment determines the length of a so-called wave.**

Increase the angle by which the moment (or spike of you will) comes to bear and the length will decrease accordingly. If it be 4000a for the blue. 300.000 into $4004.84 = 74.9$ etc x 4000 is 299,637 km/sec. That is 363 km/sec less than the constant, all because it was forced to pass around the circumference more than the previous one. That is how - not light - **but the innovation known as light** comes to travel and strikes our eyes by which first and foremost illumination comes to bear upon us, and secondly the color of things, as well as transparency, or darkness when there are no angular moments to strike our eyes.

At this point we ought also to learn how these angular moments known for light come to exist, how they are produced. By our standard light bulb the electricity, as nothing more than a rotating field of magnetic alternately brings its north and south polarities to bear upon the atoms of the tungsten element. And as they do it causes the atoms of that element to be pushed back and forth, that in turn instigates so-called spikes or dents as we might say upon the ever-present lines of nature's fundamental movement.

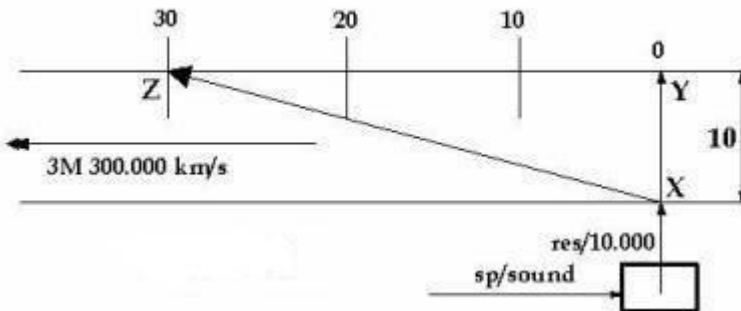

Figure 8.

By illustration Figure 8, to the left is the ever-present flow of movement to the tune of 300.000 km/sec. If then from X to Y we create an impulse at a diameter of 10a, or mm,

the circumference will be 3.14 times, since all impulses are always in the circular, all atoms having angular movement upon them. When therefore that impulse passes those 10-mm (X to Y) at a given rate, lets say one-third to the velocity of constant, with the constant itself taking it away 3 times as fast, the line of that angular would come to 30, not to zero nor to 10, because it was three to one, **just like any conveyor belt.**

Here the half length of that so-called light wave would be 30, the full nominal length coming to 60. (X to Z) The faster the impulse so much the shorter the wave will become. With radio waves the diameter is much larger, wherefore these are always much longer in the nominal. All waves now from at least 2000a to 8000a travel at the same diameter. I may not be fully accurate in this, but ballpark. Also all waves are understood by half lengths, the remainder from half to full is but gingerbread, a continuation of the first.

Next on the agenda is something we ought to realize about these types of waves how these refract or reflect. By illustration Figure 9, a solid object like a drill-bit has its point of impact at the center, while waves have it at their outer edges, in the circumference. A coordinate that passes around atoms is like a shell of a tube for which cause the angles of refraction, and reflection may vary.

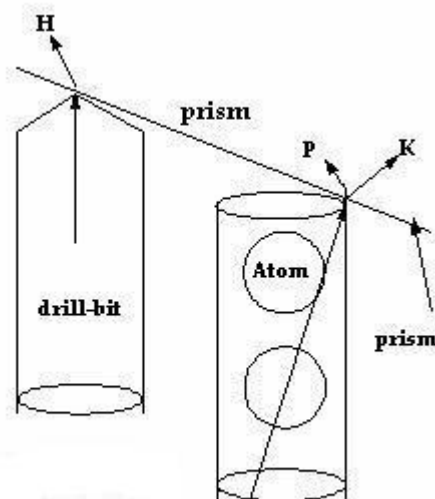

Figure 9.

Reflection all in itself is never anything like an object bouncing from a surface. When the angular moment of a wave hits a reflecting surface it merely passes through its own angular formation, wherefore its reflecting angle will be equal to its un-coming angle. The same is true for alternating current where that rotation never stops - than comes to rotate in reverse, since it merely passes through its own figure of eight. That is the reason why its alternating speed of rotation can be driven so high on those high power poles.

When a conductor of electricity is laid straight out its direction of rotation is the same all along its length as well as at its beginning and its end. But when we bend it into a U shape (Figure 5 in reference) to have its ends face each other the direction of rotation

becomes opposite from one another. These when making contact must of course destroy each other evident from short circuits.

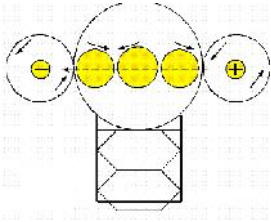

Figure 10.

But we are able to make use of these magnetic rotations simply by placing, an appeasement, a transmission in between them, as we do with our vehicles. Within a light bulb; the rotating movement of the atoms of the element serve as a transmission, and may be likened to a set of gears depicted by Figure 10. All transformers operate on that basis where instead of atoms the turns of wire serve as a transmission.

Where the transformer is utilized to produce a separate current either higher or lower in voltage, it in all reality is a generator of electricity, One magnetic potential factually generating another, the cores of them serving as the pump or flywheel to rotation. It in other words does not convert the original, although that can also be done. Here in this case the driving speed does not add to the turns in the output, but generates a whole new current relevant to the number of turns at the output.

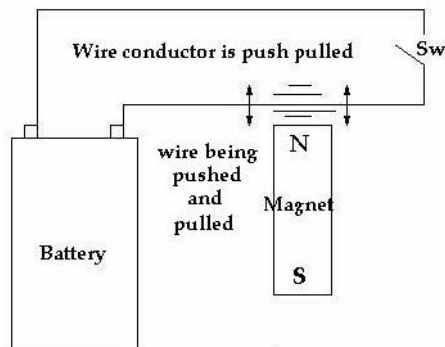

Figure 11.

Next by Figure 11, when a regular magnet is held next to a conductor of electricity, that conductor will move back and forth to the magnet. And why may that be? Obviously the electricity upon the conductor is a magnetic field, that as it rotates alternately brings is north and south polarities to that magnet. Figure 12, is an expanded view, showing the pattern of that electrical potential as figures of eight end on end, (like a breaded wire). It furthermore illustrates how in the same way it acts upon the atoms of an element whereby light-waves are produced.

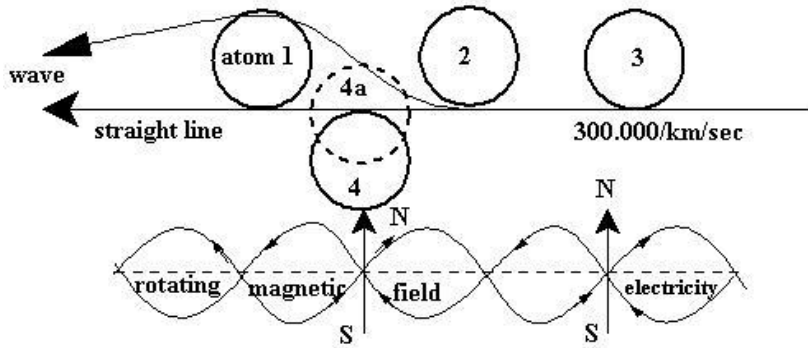

Figure 12.

This is a far cry from what man has contrived in his imagination, as if electricity were a flow of negative parts. Here in the first place, the negative of electricity as we have already learned never at all clings to any magnet, the magnet being linear while the electricity is angular. And should man not have known the difference? How fond indeed man is to invent none existent single sided coins, his so-called electrons and protons. Has one ever found a single sided coin, or a sheet of paper with only one side? How thus it is for man to wake up to reality.

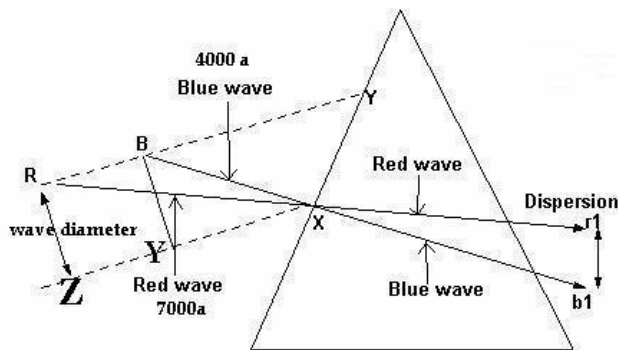

Figure 13.

To enter a quotation: "When light passes or travels from one medium to another medium there is a change in the speed of light and hence this is the reason behind refraction."

Wrong yes, very wrong. The change in speed in the first place is only for the Relative velocity of light, (distance in time) never at all for its real velocity. Secondly it is never any cause to refraction but a byproduct when light enters a different density of the media. The factual cause to refraction is a matter of incidence. All waves always travel at the full constant, the full 300.000 km/sec through any and all media no matter how dense that media may be, even solid steel.

Here by Figure 13 the red wave R to X as it strikes the prism never at all seems to refract it passes straight on through to R1. And equally so with the blue wave B to X to B1. The dispersion of these waves B1 to R1 must always be equal to R to B. The refraction to different angles lies in the length - or angular moment - of the wave. The

triangular incidence of the red wave is Z/R/X, while for the blue wave it is Y/B/X. The more acute the angle of incidence so the resultant will be.

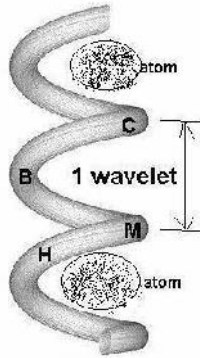

Figure 14.

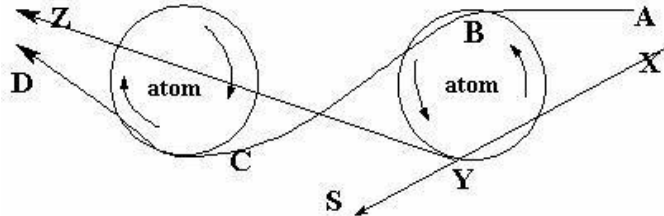

Figure 14a

Figure 14 serves to illustrate how all waves (so-called) travel, and where it notes as "1 wavelet" is as it really appears, as sectionals, single sectionals, driven forth by the all pervading fundamental movement at its constant of velocity. Like unto a coiled spring because its mode of travel proceeds in the circumference around atoms, or around whole molecules for the greater ones. There is no such thing as **waves** of the spectrum, Even the wise among the scientists have concluded that there is nothing in space or in the air for anything to cause transverse movement. By Figure 14a how could a zig-zag wave proceed from X to Y then to Z? From X to Y that so called wave would encounter a movement in contrast from that atom. If anything it would continue from Y to S.

But what might that wave consist of to be anything at all. Something of a straight line cannot possible works its way through the maze of atoms, all of which having angular movements? That ideal is completely contrary to common sense as well as in violation of all that is fundamental. A rotating segment however is the perfect way to move straight through the maze of atoms since it follows the angular momentum of these atoms By Figure 14a that is A to B to C to D following the circumference. This I added to place a handle on our senses.

No wave (so-called) now is ever continuous; to depict any wave as such is a dire fallacy. When for example we transmit our voice impulses at a wavelength that calculates into a possible frequency of 50.000, what is the real frequency at which we can make sounds? Even if every letter were a code, an impulse, we could not place more than about 80 of them on line in any one single second.

If thus the real frequency is 80 on a line that is able to hold 50.000, there are 624 empty spaces between codes, or impulses. The manufacturers of micro-waves always lie about their products as if they operated at some 2,450 Mhz. In reality these devices do not even produce ten to a hundred thousand events per second. And so it is a lie for them, because they are ignorant not only of fundamentals, but of common sense as well. They should know very well that their magnet for impulses is not anywhere near 2450 million events per second.

When we have a one meter wavelength, and there being 300 million meters in the constant per second in time, the speed of rotation would be 300 million. At a half-meter wavelength that would come to 600 million rotations in one second. But will that be for the full 300.000 km length? No, it will not be, since these so-called waves, angular moments or spikes as they really are, come to a retardation for the angular distance these must travel in the circumference. While therefore each angular moment is driven forth at 300.000-km/sec, their velocity for distance in time, properly called their **relative velocity** is curtailed. The longer lengths are always found to travel faster for distance in time, the shorter ones must turn more often in the circumference that as such increases their distance of travel in any fixed perimeter.

It is said that the speed of light in space is a constant measured at 299.792,458 meters per second. **Another fallacy of man since that is but the "Relative velocity" of light, nor is that velocity any constant, it varies in space as it varies on earth.** Man has yet to learn the difference between velocity and velocity. Nor can he be blamed for that since he at all times has been ignorant of fundamentals, and without any knowledge or insight as to what light, or any wave really is. **The fact that he calls them waves in that alone his ignorance is clearly demonstrated.**

And where he states that in space all wavelengths travel at the same velocity is of course a crock. The very fact that he measured the speed of light in space at 299.792-km/sec **is full proof of it.** With no media it should be 300.000 should it not? The answer is a yes and no, since only a straight line can travel at 300.000 for its relative velocity. And since any and all codes as angular moments must and can only be transposed by their angular deviation whereby their relative velocity is obviously curtailed here on earth as well as in space.

ELECTRICAL POTENTIAL ONCE AGAIN.

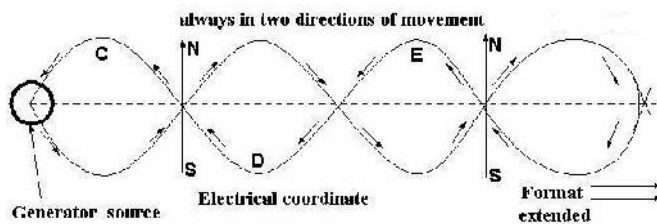

Figure 15

Figure 15 illustrates the pattern of the electrical potential upon any conductor. This cannot be seen other than by wisdom and insight. The imaginary lines encircle the body of the conductor in what is called a braided pattern instigated by the rotation of the armature within the generator, or by any pump or flywheel as previously shown. The direction of movement is therefore always into two directions along the wire, and as such they form the pattern of eight end-on-end. At every other cross section therefore exist the linear flow and direction of movement. All in all it is like magnets set end-on-end, holding to one another by their equatorial sides - so forming a single pattern.

That pattern then is extended downward along the conductor at near the speed of light. This occurs only for the instant that the current is switched on, after which the pattern remains fixed. Whatever speed of rotation it had will also remain so, unless altered. There is however no flow of current either to the right or left as normally associated with ampere. It remains fixed as illustrated rotating at its given rpm. As now voltage is speed of rotation, ampere for its proper term would be to "Quell." The only linear movement here is to either compress or expand the formation.

GRAVITATIONAL MATHEMATICS

That stars and planets are held gravitational is of course a crock. One could not be further from the truth, and we should know that, **it is sheer ignorance to be unaware of it.** We do know that the factor of gravity at sea level is 32.174 in lb. How much may this be for an astronaut some 200 miles up, or for the Hubble Space telescope? The answer comes by a simple mathematical formula credited to Sir Isaac Newton in that;

“The gravitational force of a particle in uniform motion is proportional to the square of its speed and inversely proportional to the radius of its path.”

The data on the Hubble space telescope is given at 353 miles from earth's surface. The rest of the data is: Gross weight 24,500 lb. Orbital velocity 17,500 mph. The radius thus will be 4353 miles in radius from the center of the earth. That times 5280 comes to 22,983,840 ft. Its velocity $17,500 : 60 : 60 \times 5280$ comes to 25,666 ft/sec. And to do this in whole numbers: $24,500 \times 25,666 = 628,817,000 \times 25,666 = 16,139,217,122,000$ divided by 22,983,840 = 702,198.46 lb, divided by 24,500 = 28.66.

This makes the Hubble telescope to have a g/force on it at **28.66, somewhat less than it read upon the scale**, since 702,198.46 divided by its scale weight comes to 28.66. The factor of gravity 353 miles above the earth therefore is 28.66 and its acceleration if it were to fall would be 28.66 ft/sec/sec. (At that altitude alone) When therefore we deduct the 28.66 from 32.174 (at sea level) it comes to a decrease of 3.514 in those 353 miles, and this divided by the 353 comes to 0.009,954,674 per mile. Then by dividing the sea level factor of 32.174 by the decrease per mile, comes to 3.232 miles, at which point the factor of gravity is zero, and the acceleration would be zero ft/sec/sec.

But what implication does this have? We have the habit of stating that the planets and stars are held gravitationally. But with our moon alone at a distance of some 240,000 miles, how can it possibly be held gravitational? Gravity – as the calculations shows - is but a local force, and at that the female of force to her masculine man named magnetic, Even as it is by the power of magnetic that we are drawn to the earth, with gravity providing the intricate precession whereby all substances may be embraced by those masculine arms of her man to draw it down to its center at a fixed precessional rate.

Sir Isaac Newton was right in two of his laws, but for his third law he could not possibly have known what the foundations of the earth were short of being the death of all of us. Reference Jeremiah 31:37.

CONCLUSION

What are we to make for a conclusion? First and foremost that man is in dire need of knowledge and understanding. Secondly; not to allow himself to be led by vain imagination but to look at the facts that are all around him. If then man comes to honor His Creator, by his prayers man may receive that understanding.

If on the other hand man continues to mock his Creator, the Almighty One will give him over into the power of the wicked spirits so that he will come to believe the lie, and consequently be condemned for it. God has this right, for we are His creation, and He did give us a law of life. It is fatal to any person to acclaim evolution, even as it is fatal for everyone to ignore my teaching. For my teaching is not my teaching, but as I hear from above so I speak.